















GRUPO GUILLEN

Carpintería de Madera

Puertas de Paso
ED_E1



GRUPO GUILLEN Carpinteria de Madera

<p>Puertas de Paso Laca</p> 	<p>Puertas de Entrada Laca</p> 	<p>Puertas de Sectorización Laca</p> 	<p>Ventanas</p> 
<p>Puertas de Paso Barniz</p> 	<p>Puertas de Entrada Barniz</p> 	<p>Puertas de Sectorización Barniz</p> 	<p>Balconeras</p> 
<p>Armarios Abatibles Laca</p> 	<p>Armarios Abatibles Barniz</p> 	<p>Armarios Corredera Laca</p> 	<p>Armarios Corredera Barniz</p> 



GRUPO GUILLEN Carpintería de Madera

Puertas de Paso

Laca



Barniz





PUERTA DE PASO

Puerta formada por:

- Cerco (grosso y características, dependen del sistema)
- Hoja de 35 mm. con bastidor perimetral de 30 mm. en DMF con refuerzos para resbalón (ambos lados), paramentos en DMF de 5 mm y alma.
- Tapajuntas (grosso y características, depende del sistema)
- Herraje:
 - Pernios (características depende del sistema)
 - Resbalón (características depende del sistema)
 - Juego de manivelas (opcional)

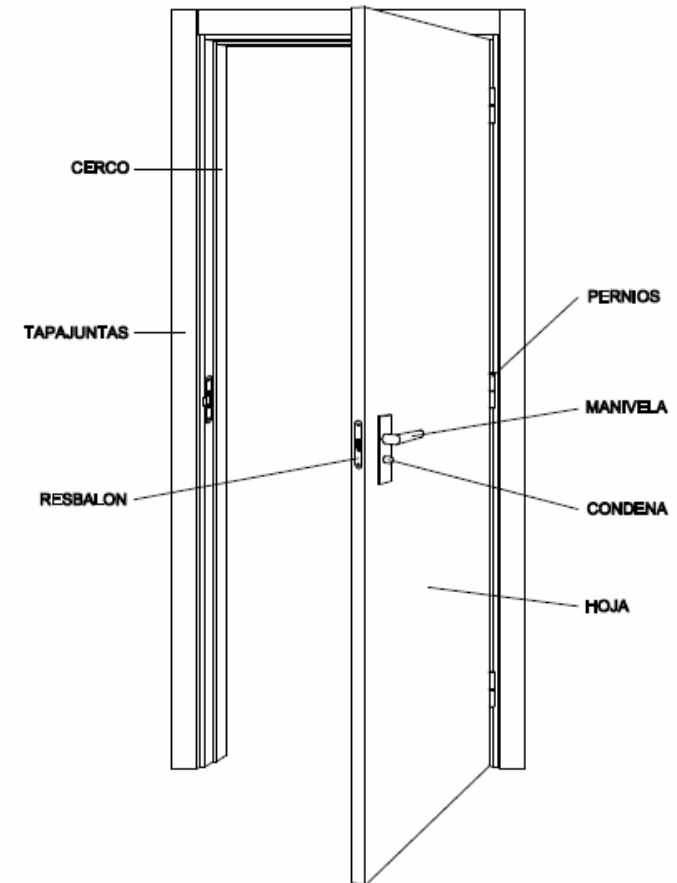



Hoja Medida:

- Ancho: 625-725-825 mm.
- Alto: 2030 mm.
- Grueso: 35 mm. (opcional 45 mm.)

Hoja Maciza (opcional): Hoja con alma llena en tablero de partículas

Herraje de colgar (pernios):



Latón



Níquel

Manivela (ver otras opciones en PE):



Latón



Níquel





Sistema Enrasado Pivotante (suministrado en kit)

- Cerco:
 - En dos piezas
 - Embocadura con junta de estanqueidad para tabiques de 70 a 130 mm
 - Para fijación a precerco de madera mediante tornillería oculta, con encuentros de tapajuntas a testa
 - **NOTA: Por el diseño y composición del cerco, la hoja queda enrasada con la cara exterior de los tapajuntas.**
- Tapajuntas: Para engargolar, de 12 mm. de espesor integrados en cerco.
- Acabado:
 - Laca Basic (3 manos de tratamiento)
 - Barniz
- Herrajes:
 - Doble gozne pivotante fijado a cerco y hoja en acabado níquel satinado (oculto a ambas caras)
 - Resbalón universal en acabado níquel satinado o latón pulido





Sistema Tradicional (suministrado en *block*)

- Cerco:
 - De 22mm Enterizo para tabiques de 70 a 130 mm
 - Para fijación a precerco de madera mediante grapas coarrugadas
- Tapajuntas:
 - De 70x10 mm. en largueros y 70x8 mm. en cabecero
 - Para fijación a testa a cerco mediante claveteados.
- Acabado:
 - Laca Basic (3 manos de tratamiento)
 - Barniz
- Herrajes:
 - Pernios convencionales en acabado níquel satinado o latón pulido
 - Resbalón universal en acabado níquel satinado o latón pulido

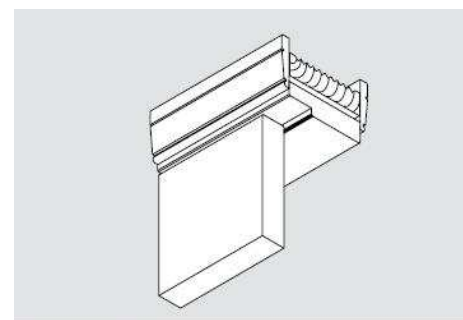



Sistema Híbrido (suministrado en *block*)

- Cerco:
 - Enterizo de 30 mm para tabiques de 70 a 120 mm
 - Con junta de estanqueidad incorporada
 - Para fijación a precerco de madera mediante tornillería oculta
- Tapajuntas:
 - De 70x16 mm. en largueros y 70x12 mm en cabecero
 - Para fijación a testa a cerco mediante sistema engargolado a cerco.
- Acabado:
 - Laca GIM (6 manos de tratamiento)
 - Barniz
- Herrajes:
 - Pernios convencionales en acabado níquel satinado o latón pulido
 - Resbalón universal en acabado níquel satinado o latón pulido



PERNIO TRADICIONAL



BISAGRA DE PILETONES, TIPO GIM, PATENTADA.



DETALLE DE ENCUENTRO EN CABECEROS.

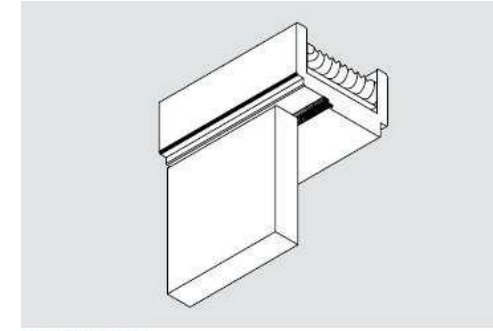

DETALLE DE SISTEMA HÍBRIDO.





Sistema Reverse (suministrado en kit)

- Cerco:
 - De 75x30mm. con embocadura de 10x10mm engargolada para tabiques de 70 a 120 mm
 - Con junta de estanqueidad incorporada
 - Para fijación a precerco de madera mediante tornillería oculta
- Tapajuntas:
 - De 70x16 mm. en largueros y 70x12 mm. en cabecero
 - Para fijación a testa a cerco mediante sistema engargolado a cerco.
- Acabado:
 - Laca GIM (6 manos de tratamiento)
 - Barniz
- Herrajes:
 - Tres bisagras especiales GIM de aluminio anodizado terminación F6 o latón, encasquillados en nylon autolubricante, AMBIVALENTE en mano, permite montar la puerta en ambos sentidos
 - Resbalón universal en acabado níquel satinado o latón pulido



BISAGRA REVERSIBLE, PATENTADA.



RESBALÓN REVERSIBLE, CON CONDENSA.



DETALLE DE ENCUENTRO EN CABECEROS.

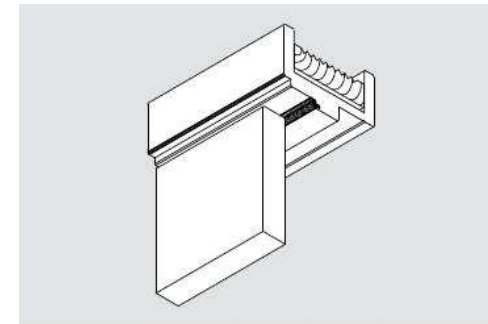

DETALLE DE SISTEMA REVERSE.





Sistema Gimnove (suministrado en *block*)

- Cerco:
 - De 37x37mm. con embocadura de 16 mm. engargolada para tabiques de 70 a 120 mm
- Con junta de estanqueidad incorporada
 - Para fijación a precerco de madera mediante tornillería oculta
- Tapajuntas:
 - De 107x12 mm. enrasado con hoja a una cara y de 70x12 mm. a la otra.
 - Para fijación a testa a cerco mediante sistema engargolado a cerco.
- Acabado:
 - Laca GIM (6 manos de tratamiento)
 - Barniz
- Herrajes:
 - Bisagras ocultas regulables 3D en acabado níquel satinado
 - Resbalón magnético en acabado níquel satinado o latón pulido

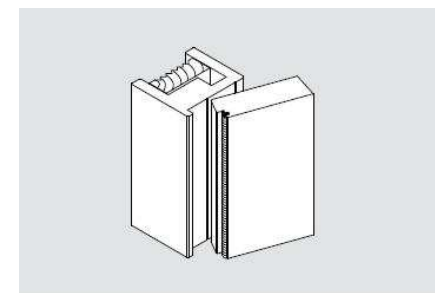

DETALLE DE SISTEMA GIMNOVE

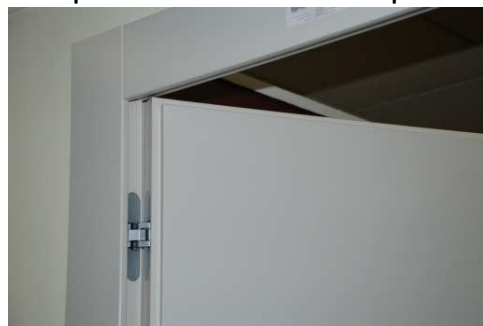

BISAGRA OCULTA

RESBALÓN MAGNÉTICO OPCIONAL





GRUPO GUILLEN Carpintería de Madera

PUERTAS PASO LACA





GRUPO GUILLEN Carpintería de Madera

Puertas de Paso

Laca

Modelo L



Modelo de Puerta L en LACA



Hoja ciega y lisa mod. L.

Opciones
(No afectan al precio)

Acabado	Ancho Hoja	Mano Hoja	Herraje	Grueso Tabique	
<input type="checkbox"/> LACA	<input type="checkbox"/> 625 mm	<input type="checkbox"/> Izquierda	<input type="checkbox"/> Laton	<input type="checkbox"/> 70 mm	<input type="checkbox"/> 100 mm
	<input type="checkbox"/> 725 mm	<input type="checkbox"/> Derecha	<input type="checkbox"/> Niquel	<input type="checkbox"/> 80 mm	<input type="checkbox"/> 110 mm
	<input type="checkbox"/> 825 mm			<input type="checkbox"/> 90 mm	<input type="checkbox"/> 120 mm

Opciones
(SI afectan al precio)

Sistema	Grueso Hoja	Hoja Maciza
<input type="checkbox"/> Hoja	<input type="checkbox"/> 35 mm	<input type="checkbox"/> NO
<input type="checkbox"/> Sistema Enrasado	<input type="checkbox"/> 45 mm	<input type="checkbox"/> SI
<input type="checkbox"/> Sistema Tradicional		
<input type="checkbox"/> Sistema Hibrido		
<input type="checkbox"/> Sistema Reverse		
<input type="checkbox"/> Sistema Gimnove		





GRUPO GUILLEN Carpintería de Madera

Puertas de Paso Laca Modelo TLH5



Modelo de Puerta TLH5 en LACA

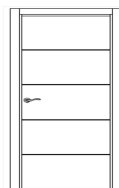

Hoja ciega pantografiada bajo relieve a ambas caras con trazo en "pico de gorrión" formando cuatro horizontales de lado a lado de la hoja mod. TLH5.

Opciones
(No afectan al precio)

Acabado	Ancho Hoja	Mano Hoja	Herraje	Grueso Tabique	
<input type="checkbox"/> LACA	<input type="checkbox"/> 625 mm	<input type="checkbox"/> Izquierda	<input type="checkbox"/> Laton	<input type="checkbox"/> 70 mm	<input type="checkbox"/> 100 mm
	<input type="checkbox"/> 725 mm	<input type="checkbox"/> Derecha	<input type="checkbox"/> Niquel	<input type="checkbox"/> 80 mm	<input type="checkbox"/> 110 mm
	<input type="checkbox"/> 825 mm			<input type="checkbox"/> 90 mm	<input type="checkbox"/> 120 mm

Opciones
(SI afectan al precio)

Sistema		Grueso Hoja	Hoja Maciza
<input type="checkbox"/> Hoja	<input type="checkbox"/> Sistema Hibrido	<input type="checkbox"/> 35 mm	<input type="checkbox"/> NO
<input type="checkbox"/> Sistema Enrasado	<input type="checkbox"/> Sistema Reverse	<input type="checkbox"/> 45 mm	<input type="checkbox"/> SI
<input type="checkbox"/> Sistema Tradicional	<input type="checkbox"/> Sistema Gimnove		





GRUPO GUILLEN Carpintería de Madera

Puertas de Paso

Laca

Modelo TL8



Modelo de Puerta L en LACA

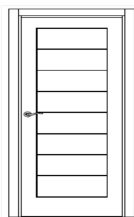

Hoja ciega pantografiada bajo relieve a ambas caras con trazo en "pico de gorrión" formando un recuadro con siete horizontales en su interior mod. TL8.

Opciones
(No afectan al precio)

Acabado	Ancho Hoja	Mano Hoja	Herraje	Grueso Tabique	
<input type="checkbox"/> LACA	<input type="checkbox"/> 625 mm	<input type="checkbox"/> Izquierda	<input type="checkbox"/> Laton	<input type="checkbox"/> 70 mm	<input type="checkbox"/> 100 mm
	<input type="checkbox"/> 725 mm	<input type="checkbox"/> Derecha	<input type="checkbox"/> Niquel	<input type="checkbox"/> 80 mm	<input type="checkbox"/> 110 mm
	<input type="checkbox"/> 825 mm			<input type="checkbox"/> 90 mm	<input type="checkbox"/> 120 mm

Opciones
(SI afectan al precio)

Sistema	Grueso Hoja	Hoja Maciza
<input type="checkbox"/> Hoja	<input type="checkbox"/> 35 mm	<input type="checkbox"/> NO
<input type="checkbox"/> Sistema Enrasado	<input type="checkbox"/> 45 mm	<input type="checkbox"/> SI
<input type="checkbox"/> Sistema Tradicional		
<input type="checkbox"/> Sistema Hibrido		
<input type="checkbox"/> Sistema Reverse		
<input type="checkbox"/> Sistema Gimnove		





GRUPO GUILLEN Carpintería de Madera

Puertas de Paso

Laca

Modelo TL2V



Modelo de Puerta TL2V en LACA

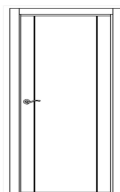

Hoja ciega pantografiada bajo relieve a ambas caras con trazo en "pico de gorrión" formando dos vertical de lado a lado de la hoja mod. TL2V.

Opciones
(No afectan al precio)

Acabado	Ancho Hoja	Mano Hoja	Herraje	Grueso Tabique	
<input type="checkbox"/> LACA	<input type="checkbox"/> 625 mm	<input type="checkbox"/> Izquierda	<input type="checkbox"/> Laton	<input type="checkbox"/> 70 mm	<input type="checkbox"/> 100 mm
	<input type="checkbox"/> 725 mm	<input type="checkbox"/> Derecha	<input type="checkbox"/> Niquel	<input type="checkbox"/> 80 mm	<input type="checkbox"/> 110 mm
	<input type="checkbox"/> 825 mm			<input type="checkbox"/> 90 mm	<input type="checkbox"/> 120 mm

Opciones
(SI afectan al precio)

Sistema		Grueso Hoja	Hoja Maciza
<input type="checkbox"/> Hoja	<input type="checkbox"/> Sistema Hibrido	<input type="checkbox"/> 35 mm	<input type="checkbox"/> NO
<input type="checkbox"/> Sistema Enrasado	<input type="checkbox"/> Sistema Reverse	<input type="checkbox"/> 45 mm	<input type="checkbox"/> SI
<input type="checkbox"/> Sistema Tradicional	<input type="checkbox"/> Sistema Gimnove		





GRUPO GUILLEN Carpintería de Madera

Puertas de Paso

Laca

Modelo TL2V5



Modelo de Puerta TL2V5 en LACA

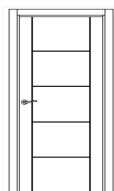

Hoja ciega pantografiada bajo relieve a ambas caras con trazo en "pico de gorrión" formando dos vertical de lado a lado de la hoja con cuatro horizontales entre éstas mod. TL2V5.

Opciones (No afectan al precio)

Acabado	Ancho Hoja	Mano Hoja	Herraje	Grueso Tabique	
<input type="checkbox"/> LACA	<input type="checkbox"/> 625 mm	<input type="checkbox"/> Izquierda	<input type="checkbox"/> Laton	<input type="checkbox"/> 70 mm	<input type="checkbox"/> 100 mm
	<input type="checkbox"/> 725 mm	<input type="checkbox"/> Derecha	<input type="checkbox"/> Niquel	<input type="checkbox"/> 80 mm	<input type="checkbox"/> 110 mm
	<input type="checkbox"/> 825 mm			<input type="checkbox"/> 90 mm	<input type="checkbox"/> 120 mm

Opciones (SI afectan al precio)

Sistema	Grueso Hoja	Hoja Maciza
<input type="checkbox"/> Hoja	<input type="checkbox"/> 35 mm	<input type="checkbox"/> NO
<input type="checkbox"/> Sistema Enrasado	<input type="checkbox"/> 45 mm	<input type="checkbox"/> SI
<input type="checkbox"/> Sistema Tradicional		
<input type="checkbox"/> Sistema Hibrido		
<input type="checkbox"/> Sistema Reverse		
<input type="checkbox"/> Sistema Gimnove		





GRUPO GUILLEN Carpintería de Madera

Puertas de Paso Laca Modelo TLR3



Modelo de Puerta TLR3 en LACA

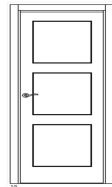

Hoja ciega pantografiada bajo relieve a ambas caras con trazo en "pico de gorrión" formando tres recuadros iguales mod. TLR3.

Opciones
(No afectan al precio)

Acabado	Ancho Hoja	Mano Hoja	Herraje	Grueso Tabique	
<input type="checkbox"/> LACA	<input type="checkbox"/> 625 mm	<input type="checkbox"/> Izquierda	<input type="checkbox"/> Laton	<input type="checkbox"/> 70 mm	<input type="checkbox"/> 100 mm
	<input type="checkbox"/> 725 mm	<input type="checkbox"/> Derecha	<input type="checkbox"/> Niquel	<input type="checkbox"/> 80 mm	<input type="checkbox"/> 110 mm
	<input type="checkbox"/> 825 mm			<input type="checkbox"/> 90 mm	<input type="checkbox"/> 120 mm

Opciones
(SI afectan al precio)

Sistema	Grueso Hoja	Hoja Maciza
<input type="checkbox"/> Hoja	<input type="checkbox"/> 35 mm	<input type="checkbox"/> NO
<input type="checkbox"/> Sistema Enrasado	<input type="checkbox"/> 45 mm	<input type="checkbox"/> SI
<input type="checkbox"/> Sistema Tradicional		
<input type="checkbox"/> Sistema Hibrido		
<input type="checkbox"/> Sistema Reverse		
<input type="checkbox"/> Sistema Gimnove		





GRUPO GUILLEN Carpintería de Madera

Puertas de
Paso

Laca

Modelo BR1



Modelo de Puerta LBR1 en LACA

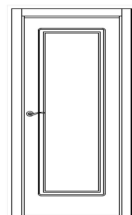

Hoja ciega pantografiada bajo relieve a ambas caras con fresado moldurado de 50x8 mm. formando un recuadro mod. BR1.

Opciones
(No afectan al precio)

Acabado	Ancho Hoja	Mano Hoja	Herraje	Grueso Tabique
<input type="checkbox"/> LACA	<input type="checkbox"/> 625 mm	<input type="checkbox"/> Izquierda	<input type="checkbox"/> Laton	<input type="checkbox"/> 70 mm
	<input type="checkbox"/> 725 mm	<input type="checkbox"/> Derecha	<input type="checkbox"/> Niquel	<input type="checkbox"/> 80 mm
	<input type="checkbox"/> 825 mm			<input type="checkbox"/> 90 mm
				<input type="checkbox"/> 100 mm
				<input type="checkbox"/> 110 mm
				<input type="checkbox"/> 120 mm

Opciones
(SI afectan al precio)

Sistema	Grueso Hoja	Hoja Maciza
<input type="checkbox"/> Hoja	<input type="checkbox"/> 35 mm	<input type="checkbox"/> NO
<input type="checkbox"/> Sistema Enrasado	<input type="checkbox"/> 45 mm	<input type="checkbox"/> SI
<input type="checkbox"/> Sistema Tradicional		
<input type="checkbox"/> Sistema Hibrido		
<input type="checkbox"/> Sistema Reverse		
<input type="checkbox"/> Sistema Gimnove		





GRUPO GUILLEN Carpintería de Madera

Puertas de Paso

Laca

Modelo BR2



Modelo de Puerta BR2 en LACA

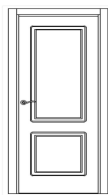

Hoja ciega pantografiada bajo relieve a ambas caras con fresado moldurado de 50x8 mm. formando dos recuadros mod. BR2.

Opciones (No afectan al precio)

Acabado	Ancho Hoja	Mano Hoja	Herraje	Grueso Tabique	
<input type="checkbox"/> LACA	<input type="checkbox"/> 625 mm	<input type="checkbox"/> Izquierda	<input type="checkbox"/> Laton	<input type="checkbox"/> 70 mm	<input type="checkbox"/> 100 mm
	<input type="checkbox"/> 725 mm	<input type="checkbox"/> Derecha	<input type="checkbox"/> Niquel	<input type="checkbox"/> 80 mm	<input type="checkbox"/> 110 mm
	<input type="checkbox"/> 825 mm			<input type="checkbox"/> 90 mm	<input type="checkbox"/> 120 mm

Opciones (SI afectan al precio)

Sistema	Grueso Hoja	Hoja Maciza
<input type="checkbox"/> Hoja	<input type="checkbox"/> 35 mm	<input type="checkbox"/> NO
<input type="checkbox"/> Sistema Enrasado	<input type="checkbox"/> 45 mm	<input type="checkbox"/> SI
<input type="checkbox"/> Sistema Tradicional		
<input type="checkbox"/> Sistema Hibrido		
<input type="checkbox"/> Sistema Reverse		
<input type="checkbox"/> Sistema Gimnove		





GRUPO GUILLEN Carpintería de Madera

Puertas de
Paso

Laca

Modelo BD2



Modelo de Puerta BD2 en LACA

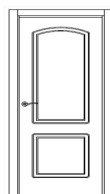

Hoja ciega pantografiada bajo relieve a ambas caras con fresado moldurado de 50x8 mm. formando dos recuadros el superior con arco rebajado mod. BD2.

Opciones
(No afectan al precio)

Acabado	Ancho Hoja	Mano Hoja	Herraje	Grueso Tabique	
<input type="checkbox"/> LACA	<input type="checkbox"/> 625 mm	<input type="checkbox"/> Izquierda	<input type="checkbox"/> Laton	<input type="checkbox"/> 70 mm	<input type="checkbox"/> 100 mm
	<input type="checkbox"/> 725 mm	<input type="checkbox"/> Derecha	<input type="checkbox"/> Niquel	<input type="checkbox"/> 80 mm	<input type="checkbox"/> 110 mm
	<input type="checkbox"/> 825 mm			<input type="checkbox"/> 90 mm	<input type="checkbox"/> 120 mm

Opciones
(SI afectan al precio)

Sistema	Grueso Hoja	Hoja Maciza
<input type="checkbox"/> Hoja	<input type="checkbox"/> 35 mm	<input type="checkbox"/> NO
<input type="checkbox"/> Sistema Enrasado	<input type="checkbox"/> 45 mm	<input type="checkbox"/> SI
<input type="checkbox"/> Sistema Tradicional		
<input type="checkbox"/> Sistema Hibrido		
<input type="checkbox"/> Sistema Reverse		
<input type="checkbox"/> Sistema Gimnove		





GRUPO GUILLEN Carpintería de Madera

Puertas de
Paso

Laca

Modelo BR3



Modelo de Puerta BR3 en LACA

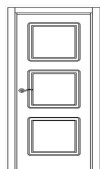

Hoja ciega pantografiada bajo relieve a ambas caras con fresado moldurado de 50x8 mm. formando tres recuadros iguales mod. BR3.

Opciones
(No afectan al precio)

Acabado	Ancho Hoja	Mano Hoja	Herraje	Grueso Tabique	
<input type="checkbox"/> LACA	<input type="checkbox"/> 625 mm	<input type="checkbox"/> Izquierda	<input type="checkbox"/> Laton	<input type="checkbox"/> 70 mm	<input type="checkbox"/> 100 mm
	<input type="checkbox"/> 725 mm	<input type="checkbox"/> Derecha	<input type="checkbox"/> Niquel	<input type="checkbox"/> 80 mm	<input type="checkbox"/> 110 mm
	<input type="checkbox"/> 825 mm			<input type="checkbox"/> 90 mm	<input type="checkbox"/> 120 mm

Opciones
(SI afectan al precio)

Sistema	Grueso Hoja	Hoja Maciza
<input type="checkbox"/> Hoja	<input type="checkbox"/> 35 mm	<input type="checkbox"/> NO
<input type="checkbox"/> Sistema Enrasado	<input type="checkbox"/> 45 mm	<input type="checkbox"/> SI
<input type="checkbox"/> Sistema Tradicional		
<input type="checkbox"/> Sistema Hibrido		
<input type="checkbox"/> Sistema Reverse		
<input type="checkbox"/> Sistema Gimnove		





GRUPO GUILLEN Carpintería de Madera

Puertas de Paso Laca Modelo BR3b



Modelo de Puerta BR3b en LACA

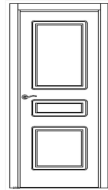

Hoja ciega pantografiada bajo relieve a ambas caras con fresado moldurado de 50x8 mm. formando tres recuadros desiguales mod. BR3b.

	Acabado	Ancho Hoja	Mano Hoja	Herraje	Grueso Tabique	
Opciones (No afectan al precio)	<input type="checkbox"/> LACA	<input type="checkbox"/> 625 mm	<input type="checkbox"/> Izquierda	<input type="checkbox"/> Laton	<input type="checkbox"/> 70 mm	<input type="checkbox"/> 100 mm
		<input type="checkbox"/> 725 mm	<input type="checkbox"/> Derecha	<input type="checkbox"/> Niquel	<input type="checkbox"/> 80 mm	<input type="checkbox"/> 110 mm
		<input type="checkbox"/> 825 mm			<input type="checkbox"/> 90 mm	<input type="checkbox"/> 120 mm

	Sistema	Grueso Hoja	Hoja Maciza
Opciones (SI afectan al precio)	<input type="checkbox"/> Hoja	<input type="checkbox"/> 35 mm	<input type="checkbox"/> NO
	<input type="checkbox"/> Sistema Enrasado	<input type="checkbox"/> 45 mm	<input type="checkbox"/> SI
	<input type="checkbox"/> Sistema Tradicional	<input type="checkbox"/> Sistema Hibrido	
	<input type="checkbox"/> Sistema Gimnove		





GRUPO GUILLEN Carpintería de Madera

Puertas de Paso

Laca

Modelo BR5



Modelo de Puerta BR5 en LACA



Hoja ciega pantografiada bajo relieve a ambas caras con fresado moldurado de 50x8 mm. formando cinco recuadros combinados "2+1+2" mod. BR5.

Opciones
(No afectan al precio)

Acabado	Ancho Hoja	Mano Hoja	Herraje	Grueso Tabique	
<input type="checkbox"/> LACA	<input type="checkbox"/> 625 mm	<input type="checkbox"/> Izquierda	<input type="checkbox"/> Laton	<input type="checkbox"/> 70 mm	<input type="checkbox"/> 100 mm
	<input type="checkbox"/> 725 mm	<input type="checkbox"/> Derecha	<input type="checkbox"/> Niquel	<input type="checkbox"/> 80 mm	<input type="checkbox"/> 110 mm
	<input type="checkbox"/> 825 mm			<input type="checkbox"/> 90 mm	<input type="checkbox"/> 120 mm

Opciones
(SI afectan al precio)

Sistema	Grueso Hoja	Hoja Maciza
<input type="checkbox"/> Hoja	<input type="checkbox"/> 35 mm	<input type="checkbox"/> NO
<input type="checkbox"/> Sistema Enrasado	<input type="checkbox"/> 45 mm	<input type="checkbox"/> SI
<input type="checkbox"/> Sistema Tradicional		
<input type="checkbox"/> Sistema Hibrido		
<input type="checkbox"/> Sistema Reverse		
<input type="checkbox"/> Sistema Gimnove		





GRUPO GUILLEN Carpintería de Madera

Puertas de Paso

Laca

Modelo PLH5



Modelo de Puerta PLH5 en LACA

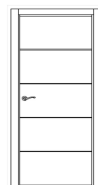

Hoja ciega pantografiada bajo relieve a ambas caras con trazo en "trapecio" de 10x3 mm. formando cuatro horizontales de lado a lado de la hoja mod. PLH5.

Opciones
(No afectan al precio)

Acabado	Ancho Hoja	Mano Hoja	Herraje	Grueso Tabique	
<input type="checkbox"/> LACA	<input type="checkbox"/> 625 mm	<input type="checkbox"/> Izquierda	<input type="checkbox"/> Laton	<input type="checkbox"/> 70 mm	<input type="checkbox"/> 100 mm
	<input type="checkbox"/> 725 mm	<input type="checkbox"/> Derecha	<input type="checkbox"/> Niquel	<input type="checkbox"/> 80 mm	<input type="checkbox"/> 110 mm
	<input type="checkbox"/> 825 mm			<input type="checkbox"/> 90 mm	<input type="checkbox"/> 120 mm

Opciones
(SI afectan al precio)

Sistema	Grueso Hoja	Hoja Maciza
<input type="checkbox"/> Hoja	<input type="checkbox"/> 35 mm	<input type="checkbox"/> NO
<input type="checkbox"/> Sistema Enrasado	<input type="checkbox"/> 45 mm	<input type="checkbox"/> SI
<input type="checkbox"/> Sistema Tradicional		
<input type="checkbox"/> Sistema Hibrido		
<input type="checkbox"/> Sistema Reverse		
<input type="checkbox"/> Sistema Gimnove		





GRUPO GUILLEN Carpintería de Madera

Puertas de Paso

Laca

Modelo RL1v



Modelo de Puerta RL1v en LACA

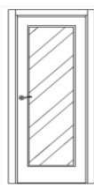

Hoja vidriera con ventano ajunquillado a ambas caras para acristalar con vidrio de 4 mm. (no incluido) mod. RL1v

Opciones
(No afectan al precio)

Acabado	Ancho Hoja	Mano Hoja	Herraje	Grueso Tabique	
<input type="checkbox"/> LACA	<input type="checkbox"/> 625 mm	<input type="checkbox"/> Izquierda	<input type="checkbox"/> Laton	<input type="checkbox"/> 70 mm	<input type="checkbox"/> 100 mm
	<input type="checkbox"/> 725 mm	<input type="checkbox"/> Derecha	<input type="checkbox"/> Niquel	<input type="checkbox"/> 80 mm	<input type="checkbox"/> 110 mm
	<input type="checkbox"/> 825 mm			<input type="checkbox"/> 90 mm	<input type="checkbox"/> 120 mm

Opciones
(SI afectan al precio)

Sistema	Grueso Hoja	Hoja Maciza
<input type="checkbox"/> Hoja	<input type="checkbox"/> 35 mm	<input type="checkbox"/> NO
<input type="checkbox"/> Sistema Enrasado	<input type="checkbox"/> 45 mm	<input type="checkbox"/> SI
<input type="checkbox"/> Sistema Tradicional		
<input type="checkbox"/> Sistema Hibrido		
<input type="checkbox"/> Sistema Reverse		
<input type="checkbox"/> Sistema Gimnove		





GRUPO GUILLEN Carpintería de Madera

Puertas de
Paso

Laca

Modelo TLH5v



Modelo de Puerta TLH5v en LACA

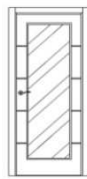

Hoja vidriera pantografiada bajo relieve a ambas caras con trazo en "pico de gorrión" formando cuatro horizontales de lado a lado de la hoja con ventano ajunquillado a ambas caras para acristalar con vidrio de 4 mm. (no incluido) mod. TLH5v.

Opciones (No afectan al precio)

Acabado	Ancho Hoja	Mano Hoja	Herraje	Grueso Tabique	
<input type="checkbox"/> LACA	<input type="checkbox"/> 625 mm	<input type="checkbox"/> Izquierda	<input type="checkbox"/> Laton	<input type="checkbox"/> 70 mm	<input type="checkbox"/> 100 mm
	<input type="checkbox"/> 725 mm	<input type="checkbox"/> Derecha	<input type="checkbox"/> Niquel	<input type="checkbox"/> 80 mm	<input type="checkbox"/> 110 mm
	<input type="checkbox"/> 825 mm			<input type="checkbox"/> 90 mm	<input type="checkbox"/> 120 mm

Opciones (SI afectan al precio)

Sistema	Grueso Hoja	Hoja Maciza
<input type="checkbox"/> Hoja	<input type="checkbox"/> 35 mm	<input type="checkbox"/> NO
<input type="checkbox"/> Sistema Enrasado	<input type="checkbox"/> 45 mm	<input type="checkbox"/> SI
<input type="checkbox"/> Sistema Tradicional		





GRUPO GUILLEN Carpintería de Madera

Puertas de Paso

Laca

Modelo TL8vc



Modelo de Puerta TL8vc en LACA

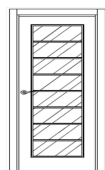

Hoja vidriera con ventano ajunquillado a ambas caras para acristalar con vidrio de 4mm (no incluido) y juego de palillera acoplada a junquillo vidriera para la simulación de 8 cristales mod.TL8vc

Opciones
(No afectan al precio)

Acabado	Ancho Hoja	Mano Hoja	Herraje	Grueso Tabique	
<input type="checkbox"/> LACA	<input type="checkbox"/> 625 mm	<input type="checkbox"/> Izquierda	<input type="checkbox"/> Laton	<input type="checkbox"/> 70 mm	<input type="checkbox"/> 100 mm
	<input type="checkbox"/> 725 mm	<input type="checkbox"/> Derecha	<input type="checkbox"/> Niquel	<input type="checkbox"/> 80 mm	<input type="checkbox"/> 110 mm
	<input type="checkbox"/> 825 mm			<input type="checkbox"/> 90 mm	<input type="checkbox"/> 120 mm

Opciones
(SI afectan al precio)

Sistema	Grueso Hoja	Hoja Maciza
<input type="checkbox"/> Hoja	<input type="checkbox"/> 35 mm	<input type="checkbox"/> NO
<input type="checkbox"/> Sistema Enrasado	<input type="checkbox"/> 45 mm	<input type="checkbox"/> SI
<input type="checkbox"/> Sistema Tradicional		
<input type="checkbox"/> Sistema Hibrido		
<input type="checkbox"/> Sistema Reverse		
<input type="checkbox"/> Sistema Gimnove		





GRUPO GUILLEN Carpintería de Madera

Puertas de Paso

Laca

Modelo TL2Vv



Modelo de Puerta TL2Vv en LACA

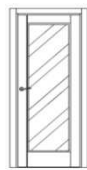

Hoja vidriera pantografiada bajo relieve a ambas caras con trazo en "pico de gorrión" formando dos vertical de lado a lado de la hoja con ventano ajunquillado a ambas caras para acristalar con vidrio de 4 mm. (no incluido) mod. TL2Vv.

Opciones
(No afectan al precio)

Acabado	Ancho Hoja	Mano Hoja	Herraje	Grueso Tabique	
<input type="checkbox"/> LACA	<input type="checkbox"/> 625 mm	<input type="checkbox"/> Izquierda	<input type="checkbox"/> Laton	<input type="checkbox"/> 70 mm	<input type="checkbox"/> 100 mm
	<input type="checkbox"/> 725 mm	<input type="checkbox"/> Derecha	<input type="checkbox"/> Niquel	<input type="checkbox"/> 80 mm	<input type="checkbox"/> 110 mm
	<input type="checkbox"/> 825 mm			<input type="checkbox"/> 90 mm	<input type="checkbox"/> 120 mm

Opciones
(SI afectan al precio)

Sistema	Grueso Hoja	Hoja Maciza
<input type="checkbox"/> Hoja	<input type="checkbox"/> 35 mm	<input type="checkbox"/> NO
<input type="checkbox"/> Sistema Enrasado	<input type="checkbox"/> 45 mm	<input type="checkbox"/> SI
<input type="checkbox"/> Sistema Tradicional		
<input type="checkbox"/> Sistema Hibrido		
<input type="checkbox"/> Sistema Reverse		
<input type="checkbox"/> Sistema Gimnove		





GRUPO GUILLEN Carpintería de Madera

Puertas de
Paso

Laca

Modelo TL2V5v



Modelo de Puerta TL2V5 v en LACA

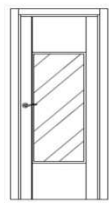

Hoja vidriera pantografiada bajo relieve a ambas caras con trazo en "pico de gorrión" formando dos vertical de lado a lado de la hoja con ventano ajunquillado a ambas caras para acristalar con vidrio de 4 mm. (no incluido) mod. TL2V5v.

Opciones
(No afectan al precio)

Acabado	Ancho Hoja	Mano Hoja	Herraje	Grueso Tabique	
<input type="checkbox"/> LACA	<input type="checkbox"/> 625 mm	<input type="checkbox"/> Izquierda	<input type="checkbox"/> Laton	<input type="checkbox"/> 70 mm	<input type="checkbox"/> 100 mm
	<input type="checkbox"/> 725 mm	<input type="checkbox"/> Derecha	<input type="checkbox"/> Niquel	<input type="checkbox"/> 80 mm	<input type="checkbox"/> 110 mm
	<input type="checkbox"/> 825 mm			<input type="checkbox"/> 90 mm	<input type="checkbox"/> 120 mm

Opciones
(SI afectan al precio)

Sistema	Grueso Hoja	Hoja Maciza
<input type="checkbox"/> Hoja	<input type="checkbox"/> 35 mm	<input type="checkbox"/> NO
<input type="checkbox"/> Sistema Enrasado	<input type="checkbox"/> 45 mm	<input type="checkbox"/> SI
<input type="checkbox"/> Sistema Tradicional		
<input type="checkbox"/> Sistema Hibrido		
<input type="checkbox"/> Sistema Reverse		
<input type="checkbox"/> Sistema Gimnove		





GRUPO GUILLEN Carpintería de Madera

Puertas de Paso Laca Modelo TLR2v



Modelo de Puerta TLR2v en LACA

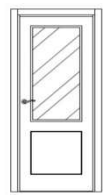

Hoja vidriera pantografiada bajo relieve a ambas caras con trazo en "pico de gorrión" formando formando un recuadro inferior con un único ventano superior ajunquillado a ambas caras para acristalar con vidrio de 4 mm. (no incluido) mod. TLR2v.

	<u>Acabado</u>	<u>Ancho Hoja</u>	<u>Mano Hoja</u>	<u>Herraje</u>	<u>Grueso Tabique</u>	
Opciones (No afectan al precio)	<input type="checkbox"/> LACA	<input type="checkbox"/> 625 mm	<input type="checkbox"/> Izquierda	<input type="checkbox"/> Laton	<input type="checkbox"/> 70 mm	<input type="checkbox"/> 100 mm
		<input type="checkbox"/> 725 mm	<input type="checkbox"/> Derecha	<input type="checkbox"/> Niquel	<input type="checkbox"/> 80 mm	<input type="checkbox"/> 110 mm
		<input type="checkbox"/> 825 mm			<input type="checkbox"/> 90 mm	<input type="checkbox"/> 120 mm

	<u>Sistema</u>	<u>Grueso Hoja</u>	<u>Hoja Maciza</u>	
Opciones (SI afectan al precio)	<input type="checkbox"/> Hoja	<input type="checkbox"/> Sistema Hibrido	<input type="checkbox"/> 35 mm	<input type="checkbox"/> NO
	<input type="checkbox"/> Sistema Enrasado	<input type="checkbox"/> Sistema Reverse	<input type="checkbox"/> 45 mm	<input type="checkbox"/> SI
	<input type="checkbox"/> Sistema Tradicional	<input type="checkbox"/> Sistema Gimnove		





GRUPO GUILLEN Carpintería de Madera

Puertas de Paso

Laca

Modelo TLR3v



Modelo de Puerta TLR3v en LACA



Hoja vidriera con tres ventanos iguales ajunquillados a ambas caras para acristalar con vidrios de 4 mm. (no incluido) mod. TLR3v.

Opciones
(No afectan al precio)

Acabado	Ancho Hoja	Mano Hoja	Herraje	Grueso Tabique	
<input type="checkbox"/> LACA	<input type="checkbox"/> 625 mm	<input type="checkbox"/> Izquierda	<input type="checkbox"/> Laton	<input type="checkbox"/> 70 mm	<input type="checkbox"/> 100 mm
	<input type="checkbox"/> 725 mm	<input type="checkbox"/> Derecha	<input type="checkbox"/> Niquel	<input type="checkbox"/> 80 mm	<input type="checkbox"/> 110 mm
	<input type="checkbox"/> 825 mm			<input type="checkbox"/> 90 mm	<input type="checkbox"/> 120 mm

Opciones
(SI afectan al precio)

Sistema	Grueso Hoja	Hoja Maciza
<input type="checkbox"/> Hoja	<input type="checkbox"/> 35 mm	<input type="checkbox"/> NO
<input type="checkbox"/> Sistema Enrasado	<input type="checkbox"/> 45 mm	<input type="checkbox"/> SI
<input type="checkbox"/> Sistema Tradicional		
<input type="checkbox"/> Sistema Hibrido		
<input type="checkbox"/> Sistema Reverse		
<input type="checkbox"/> Sistema Gimnove		





GRUPO GUILLEN Carpintería de Madera

Puertas de Paso

Laca

Modelo BR1v



Modelo de Puerta LBR1v en LACA

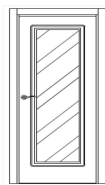

Hoja vidriera pantografiada bajo relieve a ambas caras con fresado moldurado de 50x8 mm. formando un recuadro, con ventano ajunquillado en moldurado a ambas caras para acristalar con vidrio de 4 mm. (no incluido) mod. BR1v.

Opciones
(No afectan al precio)

Acabado	Ancho Hoja	Mano Hoja	Herraje	Grueso Tabique
<input type="checkbox"/> LACA	<input type="checkbox"/> 625 mm	<input type="checkbox"/> Izquierda	<input type="checkbox"/> Laton	<input type="checkbox"/> 70 mm
	<input type="checkbox"/> 725 mm	<input type="checkbox"/> Derecha	<input type="checkbox"/> Niquel	<input type="checkbox"/> 80 mm
	<input type="checkbox"/> 825 mm			<input type="checkbox"/> 90 mm
				<input type="checkbox"/> 100 mm
				<input type="checkbox"/> 110 mm
				<input type="checkbox"/> 120 mm

Opciones
(SI afectan al precio)

Sistema	Grueso Hoja	Hoja Maciza
<input type="checkbox"/> Hoja	<input type="checkbox"/> 35 mm	<input type="checkbox"/> NO
<input type="checkbox"/> Sistema Enrasado	<input type="checkbox"/> 45 mm	<input type="checkbox"/> SI
<input type="checkbox"/> Sistema Tradicional		
<input type="checkbox"/> Sistema Hibrido		
<input type="checkbox"/> Sistema Reverse		
<input type="checkbox"/> Sistema Gimnove		





GRUPO GUILLEN Carpintería de Madera

Puertas de Paso

Laca

Modelo BD1v

Modelo de Puerta LBD1v en LACA

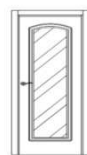

Hoja vidriera pantografiada bajo relieve a ambas caras con fresado moldurado de 50x8 mm. formando un recuadro, con ventano ajunquillado en moldurado a ambas caras para acristalar con vidrio de 4 mm. (no incluido) mod. BD1v.

Opciones (No afectan al precio)

Acabado	Ancho Hoja	Mano Hoja	Herraje	Grueso Tabique
<input type="checkbox"/> LACA	<input type="checkbox"/> 625 mm	<input type="checkbox"/> Izquierda	<input type="checkbox"/> Laton	<input type="checkbox"/> 70 mm
	<input type="checkbox"/> 725 mm	<input type="checkbox"/> Derecha	<input type="checkbox"/> Niquel	<input type="checkbox"/> 80 mm
	<input type="checkbox"/> 825 mm			<input type="checkbox"/> 90 mm
				<input type="checkbox"/> 100 mm
				<input type="checkbox"/> 110 mm
				<input type="checkbox"/> 120 mm

Opciones (SI afectan al precio)

Sistema	Grueso Hoja	Hoja Maciza
<input type="checkbox"/> Hoja	<input type="checkbox"/> 35 mm	<input type="checkbox"/> NO
<input type="checkbox"/> Sistema Enrasado	<input type="checkbox"/> 45 mm	<input type="checkbox"/> SI
<input type="checkbox"/> Sistema Tradicional		
<input type="checkbox"/> Sistema Hibrido		
<input type="checkbox"/> Sistema Reverse		
<input type="checkbox"/> Sistema Gimnove		





GRUPO GUILLEN Carpintería de Madera

Puertas de Paso Laca Modelo BD2v



Modelo de Puerta BD2v en LACA

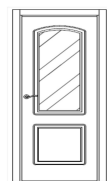

Hoja vidriera pantografiada bajo relieve a ambas caras con fresado moldurado de 50x8 mm. formando dos recuadros el superior con arco rebajado, con ventano en recuadro superior ajunquillado en moldurado a ambas caras para acristalar con vidrio de 4 mm. (no incluido) mod. BD2v.

	Acabado	Ancho Hoja	Mano Hoja	Herraje	Grueso Tabique	
Opciones (No afectan al precio)	<input type="checkbox"/> LACA	<input type="checkbox"/> 625 mm	<input type="checkbox"/> Izquierda	<input type="checkbox"/> Laton	<input type="checkbox"/> 70 mm	<input type="checkbox"/> 100 mm
		<input type="checkbox"/> 725 mm	<input type="checkbox"/> Derecha	<input type="checkbox"/> Niquel	<input type="checkbox"/> 80 mm	<input type="checkbox"/> 110 mm
		<input type="checkbox"/> 825 mm			<input type="checkbox"/> 90 mm	<input type="checkbox"/> 120 mm

	Sistema	Grueso Hoja	Hoja Maciza
Opciones (SI afectan al precio)	<input type="checkbox"/> Hoja	<input type="checkbox"/> 35 mm	<input type="checkbox"/> NO
	<input type="checkbox"/> Sistema Enrasado	<input type="checkbox"/> 45 mm	<input type="checkbox"/> SI
	<input type="checkbox"/> Sistema Tradicional	<input type="checkbox"/> Sistema Hibrido	
	<input type="checkbox"/> Sistema Gimnove		





GRUPO GUILLEN Carpintería de Madera

Puertas de Paso

Laca

Modelo BR3v



Modelo de Puerta BR3v en LACA

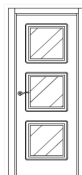

Hoja vidriera pantografiada bajo relieve a ambas caras con fresado moldurado de 50x8 mm. formando tres recuadros iguales, con tres ventano (uno en cada recuadro) ajunquillado en moldurado a ambas caras para acristalar con vidrio de 4 mm. (no incluido) mod. BR3v.

Opciones
(No afectan al precio)

Acabado	Ancho Hoja	Mano Hoja	Herraje	Grueso Tabique	
<input type="checkbox"/> LACA	<input type="checkbox"/> 625 mm	<input type="checkbox"/> Izquierda	<input type="checkbox"/> Laton	<input type="checkbox"/> 70 mm	<input type="checkbox"/> 100 mm
	<input type="checkbox"/> 725 mm	<input type="checkbox"/> Derecha	<input type="checkbox"/> Niquel	<input type="checkbox"/> 80 mm	<input type="checkbox"/> 110 mm
	<input type="checkbox"/> 825 mm			<input type="checkbox"/> 90 mm	<input type="checkbox"/> 120 mm

Opciones
(SI afectan al precio)

Sistema	Grueso Hoja	Hoja Maciza
<input type="checkbox"/> Hoja	<input type="checkbox"/> 35 mm	<input type="checkbox"/> NO
<input type="checkbox"/> Sistema Enrasado	<input type="checkbox"/> 45 mm	<input type="checkbox"/> SI
<input type="checkbox"/> Sistema Tradicional		
<input type="checkbox"/> Sistema Hibrido		
<input type="checkbox"/> Sistema Reverse		
<input type="checkbox"/> Sistema Gimnove		





GRUPO GUILLEN Carpintería de Madera

PUERTAS PASO BARNIZ





GRUPO GUILLEN Carpintería de Madera

Puertas de Paso

Barniz

Modelo C

Modelo de Puerta C en BARNIZ

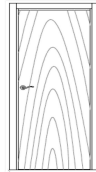

Hoja ciega chapada en madera a ambas caras con veta en vertical y cantos verticales mod. C.

Opciones (No afectan al precio)

Acabado	Ancho Hoja	Mano Hoja	Herraje	Grueso Tabique	
<input type="checkbox"/> ROBLE	<input type="checkbox"/> 625 mm	<input type="checkbox"/> Izquierda	<input type="checkbox"/> Laton	<input type="checkbox"/> 70 mm	<input type="checkbox"/> 100 mm
<input type="checkbox"/> HAYA	<input type="checkbox"/> 725 mm	<input type="checkbox"/> Derecha	<input type="checkbox"/> Niquel	<input type="checkbox"/> 80 mm	<input type="checkbox"/> 110 mm
	<input type="checkbox"/> 825 mm			<input type="checkbox"/> 90 mm	<input type="checkbox"/> 120 mm

Opciones (SI afectan al precio) Otras Maderas s/Tarifa

Sistema	Grueso Hoja	Hoja Maciza
<input type="checkbox"/> Hoja	<input type="checkbox"/> 35 mm	<input type="checkbox"/> NO
<input type="checkbox"/> Sistema Enrasado	<input type="checkbox"/> 45 mm	<input type="checkbox"/> SI
<input type="checkbox"/> Sistema Tradicional		
<input type="checkbox"/> Sistema Hibrido		
<input type="checkbox"/> Sistema Reverse		
<input type="checkbox"/> Sistema Gimnove		





GRUPO GUILLEN Carpintería de Madera

Puertas de Paso

Barniz

Modelo TCH5



Modelo de Puerta TCH5 en BARNIZ

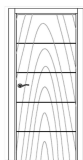

Hoja ciega chapada en madera a ambas caras con veta en vertical y cantos verticales, pantografiada bajo relieve a ambas caras con trazo en "pico de gorrión" formando cuatro horizontales de lado a lado de la hoja mod. TCH5.

Opciones
(No afectan al precio)

Acabado	Ancho Hoja	Mano Hoja	Herraje	Grueso Tabique	
<input type="checkbox"/> ROBLE	<input type="checkbox"/> 625 mm	<input type="checkbox"/> Izquierda	<input type="checkbox"/> Laton	<input type="checkbox"/> 70 mm	<input type="checkbox"/> 100 mm
<input type="checkbox"/> HAYA	<input type="checkbox"/> 725 mm	<input type="checkbox"/> Derecha	<input type="checkbox"/> Niquel	<input type="checkbox"/> 80 mm	<input type="checkbox"/> 110 mm
	<input type="checkbox"/> 825 mm			<input type="checkbox"/> 90 mm	<input type="checkbox"/> 120 mm

Opciones
(SI afectan al precio)
Otras Maderas s/Tarifa

Sistema	Grueso Hoja	Hoja Maciza
<input type="checkbox"/> Hoja	<input type="checkbox"/> 35 mm	<input type="checkbox"/> NO
<input type="checkbox"/> Sistema Enrasado	<input type="checkbox"/> 45 mm	<input type="checkbox"/> SI
<input type="checkbox"/> Sistema Tradicional		
<input type="checkbox"/> Sistema Hibrido		
<input type="checkbox"/> Sistema Reverse		
<input type="checkbox"/> Sistema Gimnove		





GRUPO GUILLEN Carpintería de Madera

Puertas de Pasa Barniz Modelo TC8



Modelo de Puerta TC8 en BARNIZ

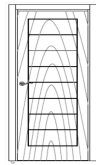

Hoja ciega chapada en madera a ambas caras con veta en vertical y cantos verticales, pantografiada bajo relieve a ambas caras con trazo en "pico de gorrión" formando un recuadro con siete horizontales en su interior mod. TC8.

Opciones	Acabado	Ancho Hoja	Mano Hoja	Herraje	Grueso Tabique	
(No afectan al precio)	<input type="checkbox"/> ROBLE	<input type="checkbox"/> 625 mm	<input type="checkbox"/> Izquierda	<input type="checkbox"/> Laton	<input type="checkbox"/> 70 mm	<input type="checkbox"/> 100 mm
	<input type="checkbox"/> HAYA	<input type="checkbox"/> 725 mm	<input type="checkbox"/> Derecha	<input type="checkbox"/> Niquel	<input type="checkbox"/> 80 mm	<input type="checkbox"/> 110 mm
		<input type="checkbox"/> 825 mm			<input type="checkbox"/> 90 mm	<input type="checkbox"/> 120 mm

Opciones	Sistema	Grueso Hoja	Hoja Maciza
(SI afectan al precio) Otras Maderas s/Tarifa	<input type="checkbox"/> Hoja	<input type="checkbox"/> 35 mm	<input type="checkbox"/> NO
	<input type="checkbox"/> Sistema Enrasado	<input type="checkbox"/> 45 mm	<input type="checkbox"/> SI
	<input type="checkbox"/> Sistema Tradicional	<input type="checkbox"/> Sistema Hibrido	
		<input type="checkbox"/> Sistema Reverse	
		<input type="checkbox"/> Sistema Gimnove	





GRUPO GUILLEN Carpintería de Madera

Puertas de
Paso

Barniz

Modelo TC2V



Modelo de Puerta TC2V en BARNIZ

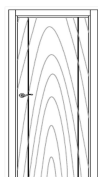

Hoja ciega chapada en madera a ambas caras con veta en vertical y cantos verticales, pantografiada bajo relieve a ambas caras con trazo en "pico de gorrión" formando dos vertical de lado a lado de la hoja mod. TC2V.

Opciones
(No afectan al precio)

Acabado	Ancho Hoja	Mano Hoja	Herraje	Grueso Tabique
<input type="checkbox"/> ROBLE	<input type="checkbox"/> 625 mm	<input type="checkbox"/> Izquierda	<input type="checkbox"/> Laton	<input type="checkbox"/> 70 mm <input type="checkbox"/> 100 mm
<input type="checkbox"/> HAYA	<input type="checkbox"/> 725 mm	<input type="checkbox"/> Derecha	<input type="checkbox"/> Niquel	<input type="checkbox"/> 80 mm <input type="checkbox"/> 110 mm
	<input type="checkbox"/> 825 mm			<input type="checkbox"/> 90 mm <input type="checkbox"/> 120 mm

Opciones
(SI afectan al precio)
Otras Maderas s/Tarifa

Sistema	Grueso Hoja	Hoja Maciza
<input type="checkbox"/> Hoja	<input type="checkbox"/> 35 mm	<input type="checkbox"/> NO
<input type="checkbox"/> Sistema Enrasado	<input type="checkbox"/> 45 mm	<input type="checkbox"/> SI
<input type="checkbox"/> Sistema Tradicional		
<input type="checkbox"/> Sistema Hibrido		
<input type="checkbox"/> Sistema Reverse		
<input type="checkbox"/> Sistema Gimnove		





GRUPO GUILLEN Carpintería de Madera

Puertas de
Paso

Barniz

Modelo TC2V5



Modelo de Puerta TC2V5 en BARNIZ

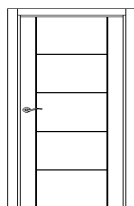

Hoja ciega chapada en madera a ambas caras con veta en vertical y cantos verticales, pantografiada bajo relieve a ambas caras con trazo en "pico de gorrión" formando dos vertical de lado a lado de la hoja con cuatro horizontales entre éstas mod. TC2V5.

Opciones
(No afectan al precio)

Acabado	Ancho Hoja	Mano Hoja	Herraje	Grueso Tabique	
<input type="checkbox"/> ROBLE	<input type="checkbox"/> 625 mm	<input type="checkbox"/> Izquierda	<input type="checkbox"/> Laton	<input type="checkbox"/> 70 mm	<input type="checkbox"/> 100 mm
<input type="checkbox"/> HAYA	<input type="checkbox"/> 725 mm	<input type="checkbox"/> Derecha	<input type="checkbox"/> Niquel	<input type="checkbox"/> 80 mm	<input type="checkbox"/> 110 mm
	<input type="checkbox"/> 825 mm			<input type="checkbox"/> 90 mm	<input type="checkbox"/> 120 mm

Opciones
(SI afectan al precio)
Otras Maderas s/Tarifa

Sistema	Grueso Hoja	Hoja Maciza
<input type="checkbox"/> Hoja	<input type="checkbox"/> 35 mm	<input type="checkbox"/> NO
<input type="checkbox"/> Sistema Enrasado	<input type="checkbox"/> 45 mm	<input type="checkbox"/> SI
<input type="checkbox"/> Sistema Tradicional		
<input type="checkbox"/> Sistema Hibrido		
<input type="checkbox"/> Sistema Reverse		
<input type="checkbox"/> Sistema Gimnove		





GRUPO GUILLEN Carpintería de Madera

Puertas de
Paso

Barniz

Modelo TCR3



Modelo de Puerta TCR3 en BARNIZ

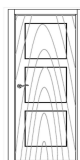

Hoja ciega chapada en madera a ambas caras con veta en vertical y cantos verticales, pantografiada bajo relieve a ambas caras con trazo en "pico de gorrión" formando tres recuadros iguales mod. TCR3.

Opciones
(No afectan al precio)

Acabado	Ancho Hoja	Mano Hoja	Herraje	Grueso Tabique	
<input type="checkbox"/> ROBLE	<input type="checkbox"/> 625 mm	<input type="checkbox"/> Izquierda	<input type="checkbox"/> Laton	<input type="checkbox"/> 70 mm	<input type="checkbox"/> 100 mm
<input type="checkbox"/> HAYA	<input type="checkbox"/> 725 mm	<input type="checkbox"/> Derecha	<input type="checkbox"/> Niquel	<input type="checkbox"/> 80 mm	<input type="checkbox"/> 110 mm
	<input type="checkbox"/> 825 mm			<input type="checkbox"/> 90 mm	<input type="checkbox"/> 120 mm

Opciones
(SI afectan al precio)
Otras Maderas s/Tarifa

Sistema	Grueso Hoja	Hoja Maciza
<input type="checkbox"/> Hoja	<input type="checkbox"/> 35 mm	<input type="checkbox"/> NO
<input type="checkbox"/> Sistema Enrasado	<input type="checkbox"/> 45 mm	<input type="checkbox"/> SI
<input type="checkbox"/> Sistema Tradicional		
<input type="checkbox"/> Sistema Hibrido		
<input type="checkbox"/> Sistema Reverse		
<input type="checkbox"/> Sistema Gimnove		





GRUPO GUILLEN Carpintería de Madera

Puertas de Paso

Barniz

Modelo IC1t



Modelo de Puerta IC1t en BARNIZ

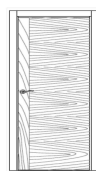

Hoja ciega chapada en madera a ambas caras y cantos verticales, taraceada a ambas caras con la veta en vertical formando un larguero y horizontal en el resto mod. IC1t.

	<u>Acabado</u>	<u>Ancho Hoja</u>	<u>Mano Hoja</u>	<u>Herraje</u>	<u>Grueso Tabique</u>	
Opciones (No afectan al precio)	<input type="checkbox"/> ROBLE	<input type="checkbox"/> 625 mm	<input type="checkbox"/> Izquierda	<input type="checkbox"/> Laton	<input type="checkbox"/> 70 mm	<input type="checkbox"/> 100 mm
	<input type="checkbox"/> HAYA	<input type="checkbox"/> 725 mm	<input type="checkbox"/> Derecha	<input type="checkbox"/> Niquel	<input type="checkbox"/> 80 mm	<input type="checkbox"/> 110 mm
		<input type="checkbox"/> 825 mm			<input type="checkbox"/> 90 mm	<input type="checkbox"/> 120 mm

	<u>Sistema</u>		<u>Grueso Hoja</u>	<u>Hoja Maciza</u>
Opciones (SI afectan al precio) Otras Maderas s/Tarifa	<input type="checkbox"/> Hoja	<input type="checkbox"/> Sistema Hibrido	<input type="checkbox"/> 35 mm	<input type="checkbox"/> NO
	<input type="checkbox"/> Sistema Enrasado	<input type="checkbox"/> Sistema Reverse	<input type="checkbox"/> 45 mm	<input type="checkbox"/> SI
	<input type="checkbox"/> Sistema Tradicional	<input type="checkbox"/> Sistema Gimnove		





GRUPO GUILLEN Carpintería de Madera

Puertas de Paso

Barniz

Modelo IC2t



Modelo de Puerta IC2t en BARNIZ

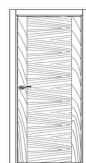

Hoja ciega chapada en madera a ambas caras y cantos verticales, taraceada a ambas caras con la veta en vertical formando dos largueros y horizontal entre éstos mod. IC2t.

Opciones
(No afectan al precio)

Acabado	Ancho Hoja	Mano Hoja	Herraje	Grueso Tabique
<input type="checkbox"/> ROBLE	<input type="checkbox"/> 625 mm	<input type="checkbox"/> Izquierda	<input type="checkbox"/> Laton	<input type="checkbox"/> 70 mm
<input type="checkbox"/> HAYA	<input type="checkbox"/> 725 mm	<input type="checkbox"/> Derecha	<input type="checkbox"/> Niquel	<input type="checkbox"/> 80 mm
	<input type="checkbox"/> 825 mm			<input type="checkbox"/> 90 mm
				<input type="checkbox"/> 100 mm
				<input type="checkbox"/> 110 mm
				<input type="checkbox"/> 120 mm

Opciones
(SI afectan al precio)
Otras Maderas s/Tarifa

Sistema	Grueso Hoja	Hoja Maciza
<input type="checkbox"/> Hoja	<input type="checkbox"/> 35 mm	<input type="checkbox"/> NO
<input type="checkbox"/> Sistema Enrasado	<input type="checkbox"/> 45 mm	<input type="checkbox"/> SI
<input type="checkbox"/> Sistema Tradicional		
<input type="checkbox"/> Sistema Hibrido		
<input type="checkbox"/> Sistema Reverse		
<input type="checkbox"/> Sistema Gimnove		





GRUPO GUILLEN Carpintería de Madera

Puertas de Paso

Barniz

Modelo GC2



Modelo de Puerta GC2 en BARNIZ

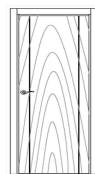

Hoja ciega chapada en madera a ambas caras y cantos verticales, la veta en vertical con dos grecas verticales de lado a lado de la hoja a ambas caras mod. GC2.

Opciones
(No afectan al precio)

Acabado	Ancho Hoja	Mano Hoja	Herraje	Grueso Tabique	
<input type="checkbox"/> ROBLE	<input type="checkbox"/> 625 mm	<input type="checkbox"/> Izquierda	<input type="checkbox"/> Laton	<input type="checkbox"/> 70 mm	<input type="checkbox"/> 100 mm
<input type="checkbox"/> HAYA	<input type="checkbox"/> 725 mm	<input type="checkbox"/> Derecha	<input type="checkbox"/> Niquel	<input type="checkbox"/> 80 mm	<input type="checkbox"/> 110 mm
	<input type="checkbox"/> 825 mm			<input type="checkbox"/> 90 mm	<input type="checkbox"/> 120 mm

Opciones
(SI afectan al precio)
Otras Maderas s/Tarifa

Sistema	Grueso Hoja	Hoja Maciza
<input type="checkbox"/> Hoja	<input type="checkbox"/> 35 mm	<input type="checkbox"/> NO
<input type="checkbox"/> Sistema Enrasado	<input type="checkbox"/> 45 mm	<input type="checkbox"/> SI
<input type="checkbox"/> Sistema Tradicional		
<input type="checkbox"/> Sistema Hibrido		
<input type="checkbox"/> Sistema Reverse		
<input type="checkbox"/> Sistema Gimnove		





GRUPO GUILLEN Carpintería de Madera

Puertas de Paso

Barniz

Modelo GC2t



Modelo de Puerta GC2t en BARNIZ

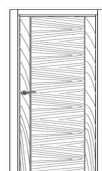

Hoja ciega chapada en madera a ambas caras y cantos verticales, taraceada a ambas caras con dos grecas verticales de lado a lado de la hoja con la veta en vertical en los largueros formados por las grecas y horizontal en el centro mod. GC2t.

Opciones
(No afectan al precio)

Acabado	Ancho Hoja	Mano Hoja	Herraje	Grueso Tabique	
<input type="checkbox"/> ROBLE	<input type="checkbox"/> 625 mm	<input type="checkbox"/> Izquierda	<input type="checkbox"/> Laton	<input type="checkbox"/> 70 mm	<input type="checkbox"/> 100 mm
<input type="checkbox"/> HAYA	<input type="checkbox"/> 725 mm	<input type="checkbox"/> Derecha	<input type="checkbox"/> Niquel	<input type="checkbox"/> 80 mm	<input type="checkbox"/> 110 mm
	<input type="checkbox"/> 825 mm			<input type="checkbox"/> 90 mm	<input type="checkbox"/> 120 mm

Opciones
(SI afectan al precio)
Otras Maderas s/Tarifa

Sistema	Grueso Hoja	Hoja Maciza
<input type="checkbox"/> Hoja	<input type="checkbox"/> 35 mm	<input type="checkbox"/> NO
<input type="checkbox"/> Sistema Enrasado	<input type="checkbox"/> 45 mm	<input type="checkbox"/> SI
<input type="checkbox"/> Sistema Tradicional		
<input type="checkbox"/> Sistema Hibrido		
<input type="checkbox"/> Sistema Reverse		
<input type="checkbox"/> Sistema Gimnove		





GRUPO GUILLEN Carpintería de Madera

Puertas de Paso Barniz Modelo R1v



Modelo de Puerta R1v en BARNIZ

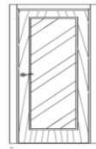

Hoja vidriera chapada en madera a ambas caras con veta en vertical y cantos verticales, con ventano ajunquillado a ambas caras para acristalar con vidrio de 4 mm. (no incluido) mod. R1v

	Acabado	Ancho Hoja	Mano Hoja	Herraje	Grueso Tabique	
Opciones (No afectan al precio)	<input type="checkbox"/> ROBLE	<input type="checkbox"/> 625 mm	<input type="checkbox"/> Izquierda	<input type="checkbox"/> Laton	<input type="checkbox"/> 70 mm	<input type="checkbox"/> 100 mm
	<input type="checkbox"/> HAYA	<input type="checkbox"/> 725 mm	<input type="checkbox"/> Derecha	<input type="checkbox"/> Niquel	<input type="checkbox"/> 80 mm	<input type="checkbox"/> 110 mm
		<input type="checkbox"/> 825 mm			<input type="checkbox"/> 90 mm	<input type="checkbox"/> 120 mm

	Sistema	Grueso Hoja	Hoja Maciza
Opciones (SI afectan al precio) Otras Maderas s/Tarifa	<input type="checkbox"/> Hoja	<input type="checkbox"/> 35 mm	<input type="checkbox"/> NO
	<input type="checkbox"/> Sistema Enrasado	<input type="checkbox"/> 45 mm	<input type="checkbox"/> SI
	<input type="checkbox"/> Sistema Tradicional	<input type="checkbox"/> Sistema Hibrido	
		<input type="checkbox"/> Sistema Reverse	
		<input type="checkbox"/> Sistema Gimnove	





GRUPO GUILLEN Carpintería de Madera

Puertas de Paso

Barniz

Modelo TCH5v



Modelo de Puerta TCH5v en BARNIZ



Hoja vidriera chapada en madera a ambas caras con veta en vertical y cantos verticales, pantografiada bajo relieve a ambas caras con trazo en "pico de gorrión" formando cuatro horizontales de lado a lado de la hoja con ventano ajunquillado a ambas caras para acristalar con vidrio de 4 mm. (no incluido) mod. TCH5v.

Opciones	Acabado	Ancho Hoja	Mano Hoja	Herraje	Grueso Tabique
(No afectan al precio)	<input type="checkbox"/> ROBLE	<input type="checkbox"/> 625 mm	<input type="checkbox"/> Izquierda	<input type="checkbox"/> Laton	<input type="checkbox"/> 70 mm
	<input type="checkbox"/> HAYA	<input type="checkbox"/> 725 mm	<input type="checkbox"/> Derecha	<input type="checkbox"/> Niquel	<input type="checkbox"/> 80 mm
		<input type="checkbox"/> 825 mm			<input type="checkbox"/> 90 mm
					<input type="checkbox"/> 100 mm
					<input type="checkbox"/> 110 mm
					<input type="checkbox"/> 120 mm

Opciones	Sistema	Grueso Hoja	Hoja Maciza
(SI afectan al precio)	<input type="checkbox"/> Hoja	<input type="checkbox"/> 35 mm	<input type="checkbox"/> NO
	<input type="checkbox"/> Sistema Enrasado	<input type="checkbox"/> 45 mm	<input type="checkbox"/> SI
	<input type="checkbox"/> Sistema Tradicional		
Otras Maderas s/Tarifa	<input type="checkbox"/> Sistema Hibrido		
	<input type="checkbox"/> Sistema Reverse		
	<input type="checkbox"/> Sistema Gimnove		





GRUPO GUILLEN Carpintería de Madera

Puertas de Paso Barniz Modelo TC8vc



Modelo de Puerta TC8vc en BARNIZ

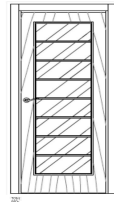

Hoja vidriera chapada en madera a ambas caras con veta en vertical y cantos verticales, con ventano ajunquillado a ambas caras para acristalar con vidrio de 4 mm. (no incluido) y juego de palillera acoplada a junquillo vidriera para la simulación de 8 cristales mod. TC8vc.

Opciones	Acabado	Ancho Hoja	Mano Hoja	Herraje	Grueso Tabique
(No afectan al precio)	<input type="checkbox"/> ROBLE	<input type="checkbox"/> 625 mm	<input type="checkbox"/> Izquierda	<input type="checkbox"/> Laton	<input type="checkbox"/> 70 mm <input type="checkbox"/> 100 mm
	<input type="checkbox"/> HAYA	<input type="checkbox"/> 725 mm	<input type="checkbox"/> Derecha	<input type="checkbox"/> Niquel	<input type="checkbox"/> 80 mm <input type="checkbox"/> 110 mm
		<input type="checkbox"/> 825 mm			<input type="checkbox"/> 90 mm <input type="checkbox"/> 120 mm

Opciones	Sistema	Grueso Hoja	Hoja Maciza
(SI afectan al precio) Otras Maderas s/Tarifa	<input type="checkbox"/> Hoja	<input type="checkbox"/> 35 mm	<input type="checkbox"/> NO
	<input type="checkbox"/> Sistema Enrasado	<input type="checkbox"/> 45 mm	<input type="checkbox"/> SI
	<input type="checkbox"/> Sistema Tradicional	<input type="checkbox"/> Sistema Hibrido	
		<input type="checkbox"/> Sistema Reverse	
		<input type="checkbox"/> Sistema Gimnove	





GRUPO GUILLEN Carpintería de Madera

Puertas de Paso

Barniz

Modelo TC2Vv



Modelo de Puerta TC2Vv en BARNIZ

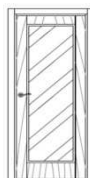

Hoja vidriera chapada en madera a ambas caras con veta en vertical y cantos verticales, pantografiada bajo relieve a ambas caras con trazo en "pico de gorrión" formando dos vertical de lado a lado de la hoja con ventano ajunquillado a ambas caras para acristalar con vidrio de 4 mm. (no incluido) mod. TC2Vv.

Opciones
(No afectan al precio)

Acabado	Ancho Hoja	Mano Hoja	Herraje	Grueso Tabique	
<input type="checkbox"/> ROBLE	<input type="checkbox"/> 625 mm	<input type="checkbox"/> Izquierda	<input type="checkbox"/> Laton	<input type="checkbox"/> 70 mm	<input type="checkbox"/> 100 mm
<input type="checkbox"/> HAYA	<input type="checkbox"/> 725 mm	<input type="checkbox"/> Derecha	<input type="checkbox"/> Niquel	<input type="checkbox"/> 80 mm	<input type="checkbox"/> 110 mm
	<input type="checkbox"/> 825 mm			<input type="checkbox"/> 90 mm	<input type="checkbox"/> 120 mm

Opciones
(SI afectan al precio)
Otras Maderas s/Tarifa

Sistema	Grueso Hoja	Hoja Maciza
<input type="checkbox"/> Hoja	<input type="checkbox"/> 35 mm	<input type="checkbox"/> NO
<input type="checkbox"/> Sistema Enrasado	<input type="checkbox"/> 45 mm	<input type="checkbox"/> SI
<input type="checkbox"/> Sistema Tradicional		
<input type="checkbox"/> Sistema Hibrido		
<input type="checkbox"/> Sistema Reverse		
<input type="checkbox"/> Sistema Gimnove		





GRUPO GUILLEN Carpintería de Madera

Puertas de Paso	Barniz	Modelo TC2V5v
-----------------	--------	---------------



Modelo de Puerta TC2V5v en BARNIZ

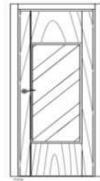

Hoja vidriera chapada en madera a ambas caras con veta en vertical y cantos verticales, pantografiada bajo relieve a ambas caras con trazo en "pico de gorrión" formando dos vertical de lado a lado de la hoja con ventano ajunquillado a ambas caras para acristalar con vidrio de 4 mm. (no incluido) mod. TC2V5v.

Opciones	Acabado	Ancho Hoja	Mano Hoja	Herraje	Grueso Tabique
(No afectan al precio)	<input type="checkbox"/> ROBLE	<input type="checkbox"/> 625 mm	<input type="checkbox"/> Izquierda	<input type="checkbox"/> Laton	<input type="checkbox"/> 70 mm
	<input type="checkbox"/> HAYA	<input type="checkbox"/> 725 mm	<input type="checkbox"/> Derecha	<input type="checkbox"/> Niquel	<input type="checkbox"/> 80 mm
		<input type="checkbox"/> 825 mm			<input type="checkbox"/> 90 mm
					<input type="checkbox"/> 100 mm
					<input type="checkbox"/> 110 mm
					<input type="checkbox"/> 120 mm

Opciones	Sistema	Grueso Hoja	Hoja Maciza
(SI afectan al precio) Otras Maderas s/Tarifa	<input type="checkbox"/> Hoja	<input type="checkbox"/> 35 mm	<input type="checkbox"/> NO
	<input type="checkbox"/> Sistema Enrasado	<input type="checkbox"/> 45 mm	<input type="checkbox"/> SI
	<input type="checkbox"/> Sistema Tradicional		
	<input type="checkbox"/> Sistema Hibrido		
	<input type="checkbox"/> Sistema Reverse		
	<input type="checkbox"/> Sistema Gimnove		





GRUPO GUILLEN Carpintería de Madera

Puertas de
Paso

Barniz

Modelo TCR2v



Modelo de Puerta TCR2v en BARNIZ

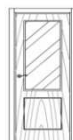

Hoja vidriera chapada en madera a ambas caras con veta en vertical y cantos verticales, pantografiada bajo relieve a ambas caras con trazo en "pico de gorrión" formando un recuadro inferior con un único ventano superior ajunquillado a ambas caras para acristalar con vidrio de 4 mm. (no incluido) mod. TCR2v

	<u>Acabado</u>	<u>Ancho Hoja</u>	<u>Mano Hoja</u>	<u>Herraje</u>	<u>Grueso Tabique</u>	
Opciones (No afectan al precio)	<input type="checkbox"/> ROBLE	<input type="checkbox"/> 625 mm	<input type="checkbox"/> Izquierda	<input type="checkbox"/> Laton	<input type="checkbox"/> 70 mm	<input type="checkbox"/> 100 mm
	<input type="checkbox"/> HAYA	<input type="checkbox"/> 725 mm	<input type="checkbox"/> Derecha	<input type="checkbox"/> Niquel	<input type="checkbox"/> 80 mm	<input type="checkbox"/> 110 mm
		<input type="checkbox"/> 825 mm			<input type="checkbox"/> 90 mm	<input type="checkbox"/> 120 mm

	<u>Sistema</u>	<u>Grueso Hoja</u>	<u>Hoja Maciza</u>
Opciones (SI afectan al precio) Otras Maderas s/Tarifa	<input type="checkbox"/> Hoja	<input type="checkbox"/> Sistema Hibrido	<input type="checkbox"/> NO
	<input type="checkbox"/> Sistema Enrasado	<input type="checkbox"/> Sistema Reverse	<input type="checkbox"/> SI
	<input type="checkbox"/> Sistema Tradicional	<input type="checkbox"/> Sistema Gimnove	





GRUPO GUILLEN Carpintería de Madera

Puertas de Paso

Barniz

Modelo TCR3v



Modelo de Puerta TCR3v en BARNIZ



Hoja vidriera chapada en madera a ambas caras con veta en vertical y cantos verticales, con tres ventanos iguales ajunquillados a ambas caras para acristalar con vidrios de 4 mm. (no incluido) mod. TCR3v.

Opciones
(No afectan al precio)

Acabado	Ancho Hoja	Mano Hoja	Herraje	Grueso Tabique	
<input type="checkbox"/> ROBLE	<input type="checkbox"/> 625 mm	<input type="checkbox"/> Izquierda	<input type="checkbox"/> Laton	<input type="checkbox"/> 70 mm	<input type="checkbox"/> 100 mm
<input type="checkbox"/> HAYA	<input type="checkbox"/> 725 mm	<input type="checkbox"/> Derecha	<input type="checkbox"/> Niquel	<input type="checkbox"/> 80 mm	<input type="checkbox"/> 110 mm
	<input type="checkbox"/> 825 mm			<input type="checkbox"/> 90 mm	<input type="checkbox"/> 120 mm

Opciones
(SI afectan al precio)
Otras Maderas s/Tarifa

Sistema	Grueso Hoja	Hoja Maciza
<input type="checkbox"/> Hoja	<input type="checkbox"/> 35 mm	<input type="checkbox"/> NO
<input type="checkbox"/> Sistema Enrasado	<input type="checkbox"/> 45 mm	<input type="checkbox"/> SI
<input type="checkbox"/> Sistema Tradicional		
<input type="checkbox"/> Sistema Hibrido		
<input type="checkbox"/> Sistema Reverse		
<input type="checkbox"/> Sistema Gimnove		





GRUPO GUILLEN Carpintería de Madera

Puertas de
Paso

Barniz

Modelo IC1tv



Modelo de Puerta IC1tv en BARNIZ



Hoja vidriera chapada en madera a ambas caras y cantos verticales, taraceada a ambas caras con la veta en vertical formando un larguero y horizontal en el resto con ventano ajunquillado a ambas caras para acristalar con vidrio de 4 mm. (no incluido) mod. IC1tv.

Opciones
(No afectan al precio)

Acabado	Ancho Hoja	Mano Hoja	Herraje	Grueso Tabique
<input type="checkbox"/> ROBLE	<input type="checkbox"/> 625 mm	<input type="checkbox"/> Izquierda	<input type="checkbox"/> Laton	<input type="checkbox"/> 70 mm <input type="checkbox"/> 100 mm
<input type="checkbox"/> HAYA	<input type="checkbox"/> 725 mm	<input type="checkbox"/> Derecha	<input type="checkbox"/> Niquel	<input type="checkbox"/> 80 mm <input type="checkbox"/> 110 mm
	<input type="checkbox"/> 825 mm			<input type="checkbox"/> 90 mm <input type="checkbox"/> 120 mm

Opciones
(SI afectan al precio)
Otras Maderas s/Tarifa

Sistema	Grueso Hoja	Hoja Maciza
<input type="checkbox"/> Hoja	<input type="checkbox"/> 35 mm	<input type="checkbox"/> NO
<input type="checkbox"/> Sistema Enrasado	<input type="checkbox"/> 45 mm	<input type="checkbox"/> SI
<input type="checkbox"/> Sistema Tradicional		
<input type="checkbox"/> Sistema Hibrido		
<input type="checkbox"/> Sistema Reverse		
<input type="checkbox"/> Sistema Gimnove		





GRUPO GUILLEN Carpintería de Madera

Puertas de Paso

Barniz

Modelo IC2tv



Modelo de Puerta IC2tv en BARNIZ

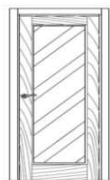

Hoja vidriera chapada en madera a ambas caras y cantos verticales, taraceada a ambas caras con la veta en vertical formando dos largueros y horizontal entre éstos con ventano ajunquillado a ambas caras para acristalar con vidrio de 4 mm. (no incluido) mod. IC2tv.

Opciones
(No afectan al precio)

Acabado	Ancho Hoja	Mano Hoja	Herraje	Grueso Tabique	
<input type="checkbox"/> ROBLE	<input type="checkbox"/> 625 mm	<input type="checkbox"/> Izquierda	<input type="checkbox"/> Laton	<input type="checkbox"/> 70 mm	<input type="checkbox"/> 100 mm
<input type="checkbox"/> HAYA	<input type="checkbox"/> 725 mm	<input type="checkbox"/> Derecha	<input type="checkbox"/> Niquel	<input type="checkbox"/> 80 mm	<input type="checkbox"/> 110 mm
	<input type="checkbox"/> 825 mm			<input type="checkbox"/> 90 mm	<input type="checkbox"/> 120 mm

Opciones
(SI afectan al precio)
Otras Maderas s/Tarifa

Sistema	Grueso Hoja	Hoja Maciza
<input type="checkbox"/> Hoja	<input type="checkbox"/> 35 mm	<input type="checkbox"/> NO
<input type="checkbox"/> Sistema Enrasado	<input type="checkbox"/> 45 mm	<input type="checkbox"/> SI
<input type="checkbox"/> Sistema Tradicional		
<input type="checkbox"/> Sistema Hibrido		
<input type="checkbox"/> Sistema Reverse		
<input type="checkbox"/> Sistema Gimnove		





GRUPO GUILLEN Carpintería de Madera

Puertas de Paso

Barniz

Modelo GC2tv



Modelo de Puerta GC2tv en BARNIZ

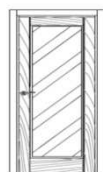

Hoja vidrierachapada en madera a ambas caras y cantos verticales, taraceada a ambas caras con dos greclas verticales de lado a lado de la hoja con la veta en vertical en los largueros formados por las greclas y horizontal en el centro con ventano ajunquillado a ambas caras para acristalar con vidrio de 4 mm. (no incluido) mod. GC2tv.

Opciones
(No afectan al precio)

Acabado	Ancho Hoja	Mano Hoja	Herraje	Grueso Tabique
<input type="checkbox"/> ROBLE	<input type="checkbox"/> 625 mm	<input type="checkbox"/> Izquierda	<input type="checkbox"/> Laton	<input type="checkbox"/> 70 mm <input type="checkbox"/> 100 mm
<input type="checkbox"/> HAYA	<input type="checkbox"/> 725 mm	<input type="checkbox"/> Derecha	<input type="checkbox"/> Niquel	<input type="checkbox"/> 80 mm <input type="checkbox"/> 110 mm
	<input type="checkbox"/> 825 mm			<input type="checkbox"/> 90 mm <input type="checkbox"/> 120 mm

Opciones
(SI afectan al precio)
Otras Maderas s/Tarifa

Sistema	Grueso Hoja	Hoja Maciza
<input type="checkbox"/> Hoja	<input type="checkbox"/> 35 mm	<input type="checkbox"/> NO
<input type="checkbox"/> Sistema Enrasado	<input type="checkbox"/> 45 mm	<input type="checkbox"/> SI
<input type="checkbox"/> Sistema Tradicional		
<input type="checkbox"/> Sistema Hibrido		
<input type="checkbox"/> Sistema Reverse		
<input type="checkbox"/> Sistema Gimnove		



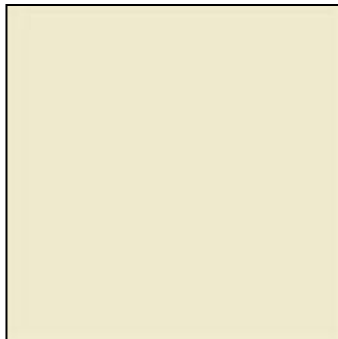

RAL 9001



RAL 9010



RAL 7011



RAL 9003



RAL NCS 1502-Y50R

Otros acabados consultar precio

Nota: Los tonos y colores son orientativos, ya que dependen de la impresión. La empresa no se hace responsable de la exactitud de los mismos.





Maderas Naturales



HAYA

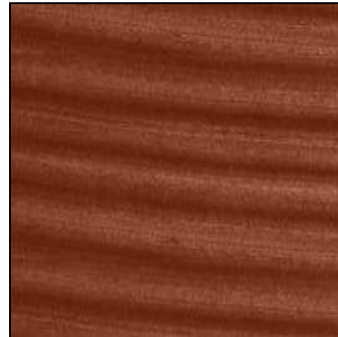

SAPELLY



CEREZO



NOGAL



ROBLE



IROKO



PINO OREGON



ARCE

Otros acabados consultar precio

Nota: Los tonos y colores son orientativos, ya que dependen de la impresión. La empresa no se hace responsable de la exactitud de los mismos.





Maderas Ecológicas



CEREZO



WENGUE



ROBLE DECAPE

Otros acabados consultar precio

Nota: Los tonos y colores son orientativos, ya que dependen de la impresión. La empresa no se hace responsable de la exactitud de los mismos.





GRUPO GUILLEN Carpintería de Madera

AMBIENTES



Nota: Los tonos y colores son orientativos, ya que dependen de la impresión. La empresa no se hace responsable de la exactitud de los mismos.





GRUPO GUILLEN Carpintería de Madera

AMBIENTES



Nota: Los tonos y colores son orientativos, ya que dependen de la impresión. La empresa no se hace responsable de la exactitud de los mismos.

